

Varenummer: 03553035

Beskrivelse: Fluro hydraulik ledhoved FPR 35U

Mål

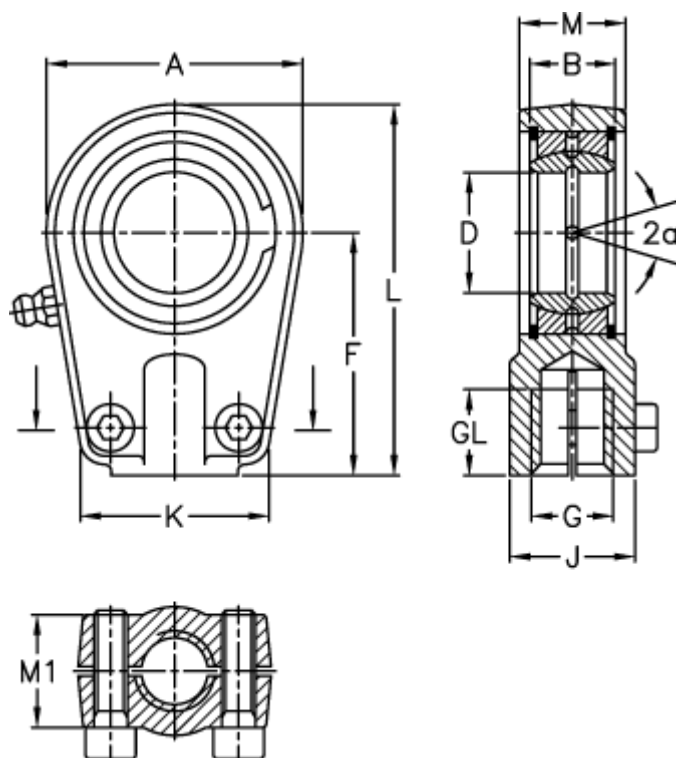

A	= 78	J	= 40
a (grader)	= 6	K	= 66
B	= 25	L	= 112
D	= 35	M	= 30
Dynamisk belastning C (kN)	= 80	M1	= 28
F	= 70	Moment (Nm)	= 49
g	= M28x1,5	Statisk belastning C0 (kN)	= 153
GL	= 29	Vægt	= 1150